

FREESKY[®]
go anywhere

 <https://www.freeskycycle.uk>



FREESKY[®]
go anywhere

USER MANUAL



26" WARRIOR ELECTRIC BIKE

YANSAN Technology Co., LTD

Feel free to contact us if you experience issues relating to error codes, faults, maintenance or safety with your FREESKY e-bike.

 <https://www.freeskycycle.uk>

 serve.uk@freeskycycle.com

 <https://www.youtube.com/@freeskyebike>

 <https://www.facebook.com/groups/freeskyebike>

Thank You for Choosing a Freesky E-bike!

We are delighted to present you with a high-quality product which is designed to provide years of pleasure. Kindly review this user manual thoroughly before assembling and riding your e-bike. If you have any questions after reading this manual, please reach out to us via email or give us a call.

Take Down Your Serial Numbers Here!

Bike frame serial number

[Redacted]

Motor serial number

[Redacted]

Display serial number

[Redacted]

Please note that the FREESKY e-bike is now available through various sales channels. For the fastest assistance, email us with your purchase date and order ID. You can also call us if necessary

Order ID: Locate it in the order history of the account used for the purchase.

You can find your e-bike's serial number on the bike frame, typically located near the bottom of the head tube. This unique code helps us manage warranty issues, identify the model and year of manufacture, and also handle theft claims if needed.



Frame Serial Number is engraved on the head tube

Display Serial Number Location

Motor Serial Number Location

1. The serial number is usually on the motor, starting from the left side (brake disc side).
2. You can find the display serial number on the back of the display.
3. The head tube also has an engraved serial number.

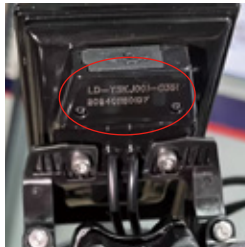

TABLE OF CONTENTS

UNDERSTANDING YOUR WARRIOR PRO M-530	7
WHAT'S IN THE BOX	8
HOW TO REMOVE THE BATTERY?	9
CHARGE THE BATTERY	10
ASSEMBLY	12
OPERATING YOUR NEW E-BIKE	18
RECOMMENDED SERVICE INTERVALS	21
PRE-RIDE SAFETY CHECKLIST	22
TIRE INFLATION AND REPLACEMENT	24
TROUBLESHOOTING	25
SPECIFICATIONS	26
WARRANTY	27

PLEASE NOTE:

This manual is not intended as a detailed user, service, repair or maintenance manual. Please seek assistance from a qualified technician for service, repairs or maintenance.

Your First Ride

Exercise extreme caution when taking your e-bike for the first time, as it can accelerate much faster than a regular bicycle when in power-assisted mode. Start by riding in a spacious area to give yourself plenty of room. Avoid pedaling hard immediately upon mounting the e-bike, as the pedal-assist mode will cause a rapid increase in speed that might catch you off guard. With a bit of practice, you'll become accustomed to and enjoy the benefits of the pedal-assisted function.

Operating Instructions

Read This First: Safety and Compliance with the Law Before operating your bike, ensure that it has been assembled correctly according to the provided assembly video, that all components are securely fastened, and a certified, reputable mechanic has inspected the assembly. Once you've read this entire manual, you can turn on the bike and select a pedal assist level by following the steps below:

When you strap on your helmet and go for your first ride, choose an area free from cars, other cyclists, obstacles, or hazards to get familiar with your electric bike's controls, features, and performance.

If this is your first time riding an e-bike, we recommend starting with PAS level 0 to get comfortable with the bike.

With the proper safety gear and knowledge, you are ready to ride. On flat terrain, in a low gear (1 or 2), and using rear-wheel drive only, most riders can begin pedaling with pedal assist set to level 0 or 1. You can also use the throttle to accelerate and maintain your preferred speed.

Recommended Rider Size

To ensure the safe operation of the bike, it is essential to understand how to use it properly and adhere to all local traffic, bicycle laws, and regulations. Riders must be at least 18 years old. It is your responsibility to determine if you can ride the bike safely.

UNDERSTANDING YOUR WARRIOR PRO M-530

Your WARRIOR is an all-wheel drive, Class 3 eBike with a 2000-watt power drive system.

It's important to understand that the bike has two completely separate (but complimentary) drive systems;



- an electric drive system that powers the bike through the controller and/ or throttle
- a seven-speed system you power by pedaling by yourself

Although the two systems work independently, using them together is what makes the eBike experience so versatile and enjoyable.

Important note: Because your M530 WARRIOR is a rear-hub drive, the gear system is for pedal power only, and does not affect how the electric power system drives the bike.



WHAT'S IN THE BOX

 <p>1x User Manual</p>	 <p>2x Pedals</p>	 <p>Headlight</p>
 <p>1x Front Wheel</p>	 <p>1x Saddle</p>	 <p>2x Wrench 7x Allen Key Wrench</p>
 <p>2x Keys</p>	 <p>1x Charger</p>	 <p>1x Electric Bike</p>

Carefully inspect the package contents. If any parts are missing or damaged, contact FREESKY customer service immediately and provide your order ID for assistance.

service@freeskycycle.com(Freeskycycle website)

support@freeskycycle.com (Amazon)

It is recommended to retain the original packaging for a short period of time and keep it as intact as possible

For warranty and returns, you are responsible for providing a new box at your expense if you have discarded the original box in which the product was shipped **PLEASE RETAIN YOUR BIKE BOX** even if it has been damaged in shipping

Riding a bicycle comes with inherent risks, and it is your responsibility to ride safely and within your skill level. Proper assembly is crucial for the safe use of your bike, so if you're unable to follow the assembly instructions provided in this manual, seek professional help.

Before assembling your bike, it's advisable to remove the battery for the following reasons:

- To check if the battery was drained or damaged during transportation.
- To reduce the bike's weight, making it easier to handle during assembly.
- To prevent any potential damage to the battery while assembling.

HOW TO REMOVE THE BATTERY?

For your convenience, the FREESKY bike's battery is designed to be removable



1. Make sure the bike is turned off. Insert the key into the key port and rotate it to align with the off icons, ensuring the key is in the correct off position.

2. Gently grasp the battery and take it out of the frame.

Note: the battery is approximately 13 lbs and must be handled cautiously.

3. When removing the battery, be careful not to drop or damage it while it's detached from the bike. Avoid harming the exposed connector terminals and keep them free of debris. When installing the battery, make sure it is turned off before placing it into the frame mount. Ensure that the battery is securely fastened to the bike before each use.



Charge the Battery on the Bike

Before using the electric bike, you must fully charge the battery.



1. Remove the rubber cover from the battery's charging port.
2. Insert the charger into the battery's charging port. Whether the battery is on or off the bike, place the charger on a flat, secure surface and connect the DC output plug of the charger to the battery's charging port.

3. Plug the charger into a power outlet. Charging will begin, indicated by the LED charge status light on the charger turning red. When the battery is fully charged, the indicator light will turn green.

4. Unplug the charger from the wall outlet before removing the output plug from the battery's charging port.

CHARGE YOUR BATTERY OFF THE BIKE



1. The battery can be charged separately from the bike. To remove it, securely hold the battery while turning the key to the "unlock" position to prevent it from falling to the ground.



2. Connect the charger to a power outlet, and charging will begin, as shown by the LED status lights on the charger turning red. When fully charged, the indicator light will turn green.

HEADSTOCK ASSEMBLY



1. Lightly fasten the top of the faceplate.



2. Place the handlebar into the locknut on the stem.



3. Center the handlebar and adjust the direction, make sure the handlebar is centered on the stem.



4. Use a wrench to tighten the screw and secure the handlebar stem in place.

FRONT WHEEL ASSEMBLY

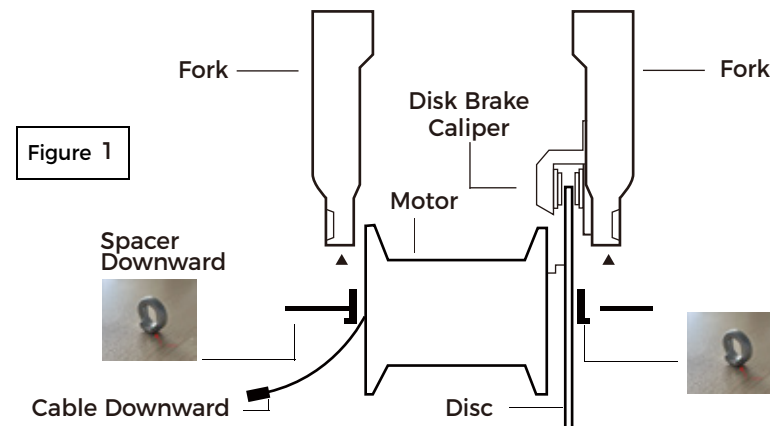

1. Take off the red protective piece from the brake caliper.
2. Place the spacers onto the motor axle, one on each side. Ensure the spacer is facing downward with the tongue pointing toward the fork.
3. Position the disc between the brake caliper, as illustrated in figure.
4. Insert the front wheel between the front fork of the bike, ensuring that the fork is positioned on the outside of the axle.

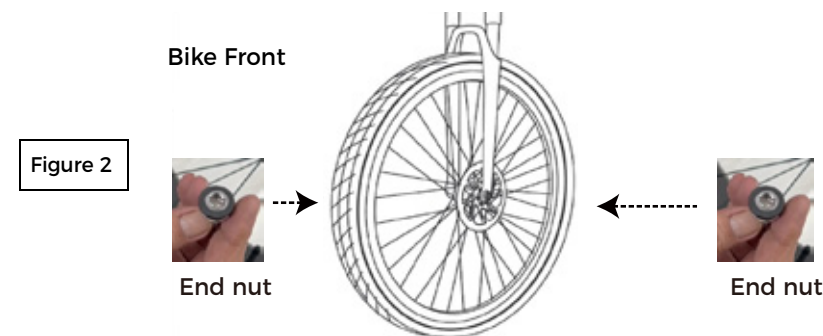

5. Tighten the screws on both sides. (45N.m to 50N.m)
6. Lift the front wheel and spin it to ensure it moves smoothly.

HEADLIGHT ASSEMBLY



1. Place the headlight on the fork's arch and locate the bolt hole.



2. Secure the nut and tighten the bolt.



3. Connect the yellow headlight cable, making sure to align it with the arrow mark on the cable.

SADDLE ASSEMBLY

For optimal pedaling efficiency, safety, and overall comfort, it's crucial to position the seat at the correct height. The rider's leg length helps determine this position. When pedaling, your hips should stay level and your legs should be nearly fully extended at the bottom of the pedal stroke, but not over-extended. To find the right seat height, sit on the e-bike with one pedal at its lowest point and place the ball of your foot on the pedal. Your leg should be almost fully extended (but not locked) with a slight bend at the knee.



1. Open the quick-release lever by swinging it fully outward.



2. Adjust the seat height by sliding the seatpost in or out of the seat tube. Make sure not to raise the seat post beyond the minimum insertion mark on the seat post tube.

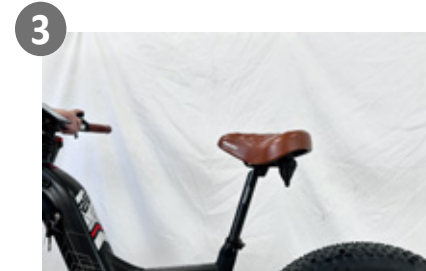

3. Align the seat so that the front of the seat is parallel to the top tube.

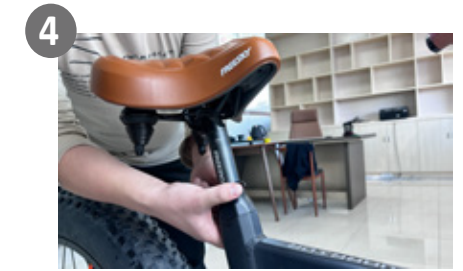

4. Close the quick-release lever by pressing it firmly with your palm or finger.

SADDLE ADJUSTMENT

Adjusting the Seat Position and Angle

To change the angle and horizontal position of the seat:

1. Use an allen wrench to loosen the seat adjustment bolt on the clamp located just below the seat, above the rear wheel. Do not fully remove the bolt.
2. Adjust the seat by moving it backward or forward and tilting it to achieve the desired angle. For most riders, a horizontal seat position is ideal. Ensure you do not exceed the limit markings on the seat rail, which indicate the allowable range of horizontal movement.
3. While keeping the seat in your desired position, use the allen wrench to securely tighten the seat adjustment bolt to the recommended torque value.



Before using the bike for the first time, ensure the seat clamp is properly tightened via the seat adjustment bolt. A loose seat clamp or seatpost adjustment bolt can lead to bike damage, property damage, loss of control, falls, serious injury, or even death. Regularly inspect the seat clamp to confirm it is securely fastened.

SUSPENSION FORK ADJUSTMENT

Adjusting the Suspension Fork



The preload adjustment knob (1), located on top of the left side of the suspension fork, allows you to customize the suspension's resistance. To soften the ride, reduce resistance by turning the knob counterclockwise, in the direction of the small "-" symbol. To stiffen the suspension for a firmer ride over bumps, increase resistance by turning the knob clockwise, in the direction of the small "+" symbol.

The lockout lever (2), located on the top of the right side of the suspension fork, can be turned counterclockwise until it stops to fully lock out the suspension fork's movement. To unlock the suspension, turn the lever clockwise until it stops. Once unlocked, the resistance can be adjusted by turning the lever.

PEDALS ASSEMBLY

1. **** Warning ****: Improper installation can lead to damage. Please read the instructions carefully and watch our instructional videos if necessary.

2. Identify the "Left" (L) and "Right" (R) markings on the pedals, as they must be installed on the correct side.

- **** L **** is for the Left Pedal, which should be attached to the Left Crank Arm.

- **** R **** is for the Right Pedal, which should be attached to the Right Crank Arm (chain side).

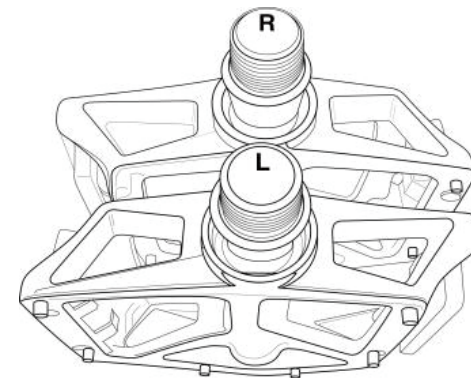

3. While sitting on your bike, the pedals should be installed on the Left and Right sides accordingly.
4. Hold the pedal horizontally and hand-screw it to start the threading. Then, use a 15mm wrench to tighten.
5. Both pedals tighten by turning towards the front of the bike. The left pedal is reverse-threaded to allow for this.
6. Ensure the pedals are very tight and remember to recheck and retighten them after your first few rides.

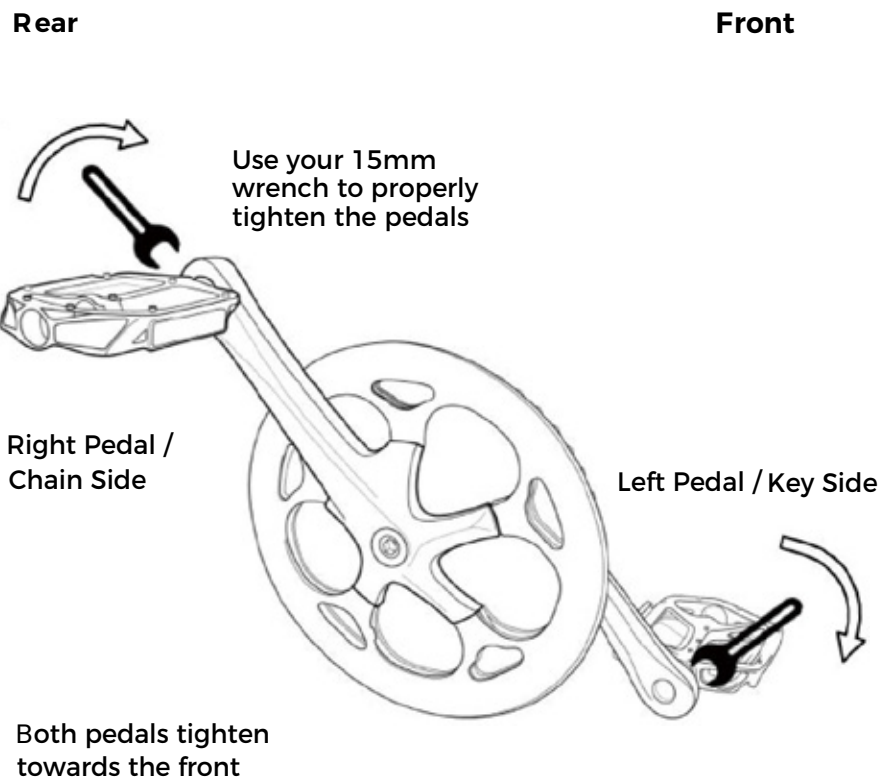

OPERATING YOUR NEW E-BIKE

1. Turn on the switch of the battery.
2. To turn on the electric system and controller, press and hold the  button for 2 seconds.





To turn the system off, do the same, Press and hold the  button for 2 seconds. In addition, the system will turn itself off if the bike is still for 5 minutes. (This time can be changed in Display Settings.)

3. Enter the password: 1212 (It is a default password and is used to power on the e-bike. It can be reset).

The bike can be turned on with the NFC tag. When the bike is off, no need to press and hold the "power" button, put the NFC tag on the bottom of the display directly.

4. Start riding the bike using pedal power.
 5. Once you're steady and stable, press the  button to select the PAS 1, enabling the electric assist.
 6. Begin pedaling, and after a rotation or two, you will feel the electric assist engage.
 7. When you're ready to ride under electric power only, gently press the throttle until the bike moves forward.
 8. Use the brakes to come to a stop when you're ready.
- ◆ The electric power system won't engage if the bike is already going faster than the PAS 1 (approximately 10 MPH /16 kph).

After your initial ride, you can experiment with higher modes, using the  and buttons  change them.

(Remember: PAS 0 will turn off the electric drive. Setting PAS 1 or higher will turn it on again.)

USING THE GEARING SYSTEM

The pedal system should be familiar to most users, but here are a few tips to help you get the most out of it:

1. ****Gear Selection****: Use the two buttons on the right handlebar to choose the best gear for your riding conditions. The optimal gear strikes a balance between requiring too much effort and pedaling so fast that you can't exert much force.
2. ****Pedaling for Gear Changes****: Gears will only change when you're pedaling forward, so ensure you're pedaling while shifting gears.
3. ****Low Gear for Starts****: Select a low gear when starting to move again after a stop. This makes it easier to get going after slowing down.
4. ****Effect on Electric Drive****: Since your bike has a rear-hub drive system, the gears in the pedal drive system do not affect the electric drive system.

If you want to operate your bike a pedal-only mode, select Mode ① (see Operating Modes)

USING THE PURE ELECTRIC SYSTEM

No need to pedal, press the throttle when it is PAs 1 or higher.

Note: PAs 1-5 will not affect the throttle speed. PAs 0 will turn off the electric drive.

SAFETY TIPS

We Recommend The Following Safety-related Procedures:

- **** Wear a Helmet ****: Always wear a helmet for safety.
- **** Ride in Control ****: Maintain control of your bike at all times.

- **** Use Lights and Reflective Gear ****: Equip your bike with lights and wear reflective gear in low-light conditions.
- **** Inspect Your Bike Regularly ****: Check your bike frequently, especially the brakes.
- **** Seek Maintenance ****: If you notice any changes in bike performance, have it checked by a professional.
- **** Know and Follow Road Rules ****: Familiarize yourself with and adhere to all road rules for cyclists.
- **** Ride Defensively ****: Be aware that you may not be as visible to motorists, pedestrians, or other cyclists as you think. Always be prepared to stop or take evasive action. The electric motor may make you travel faster than drivers expect.
- **** Avoid Road Hazards ****: Steer clear of potholes, drain grates, railroad tracks, loose road material, and other potential hazards.
- **** Use Both Brakes ****: For optimal stopping performance, use both the front and rear brakes. Relying only on the rear brake will significantly increase your stopping distance.

Cycling on sidewalks or pavements can increase the risk of accidents for both you and pedestrians. E-bikes can travel faster than traditional bicycles, making this risk even higher.

Be cautious of all road users. According to AXcess (source), drivers may not always recognize how fast you are traveling and might assume you're moving much slower than you are. To minimize the risk of accidents, always yield to cars and avoid rushing. Exercise patience and stay alert, especially at intersections and turns.

Guide to Cycling At Night

Use Lights Properly: When riding at night, ensure you have lights on both the front and rear of your bike.

For added safety, consider using a clip-on light for your helmet or investing in a helmet with a built-in LED light. Wearing a light vest over your clothing can enhance visibility, allowing drivers to see you from a greater distance and ensuring they pass with sufficient clearance. Always turn on any built-in lights before heading out to ride.

Recommended Service Intervals

Regular inspection and maintenance are key to ensure bikes from Freesky function as intended and to reduce wear and tear on their systems. Recommended service intervals are meant to be used as guidelines. Real-world wear and tear, and the need for service will vary with the condition of use. We generally recommend inspections, service, and necessary replacements be performed at the time or mileage interval that comes first in the following table.

Interval	Inspect	Service	Replace
Weekly, 100-200 miles (160-321 km)	1. Check drivetrain for proper alignment and function (including the chain, freewheel, chainring, and derailleur). 2. Check wheel trueness and for quiet wheel operation (without spoke noise). 3. Check condition of frame for any damage.	1. Clean frame by wiping frame down with damp cloth. 2. Use barrel adjuster(s) to tension derailleur/brake cables if needed.	1. Replace any components confirmed by Freesky, Product Support or a certified, reputable bike mechanic.
Monthly, 250-750 miles (402-1207km)	1. Check bike is shifting properly, proper derailleur cable tension. 2. Check chain stretch. 3. Check spoke tension. 4. Check accessory mounting (rack mounting bolts, and alignment). 5. Check that the screws are secured	1. Clean and lubricate drivetrain. 2. Check crankset and pedal torque. 3. Clean brake and shift cables. 4. True and tension wheels if any loose spokes are discovered. 5. Balance the battery. 6. Tighten the screws.	1. Replace brake and shift cables if necessary. 2. Replace brake pads if necessary.
Every 6 Months, 750-1250 miles (1207-2011km)	1. Inspect drivetrain (chain, chainring, freewheel, and derailleur). 2. Inspect all cables and housings.	1. Standard tune-up by certified, reputable bike mechanic is recommended. 2. Grease bottom bracket.	1. Replace brake pads. 2. Replace tires if necessary. 3. Replace cables and housings if necessary.

Pre-Ride Safety Checklist

Notice: Before every ride, and after every 25-45 miles(40-72 km), we advise you following the pre-ride safety checklist.

Safety Check	
1.Brakes	Ensure front and rear brakes work properly. Check brake pads for wear and ensure they are not overworn. Ensure brake pads are correctly positioned in relation to the rims. Ensure brake levers are lubricated and tightly secured to the handlebar. Test that the brake levers are firm and that the brake is functioning properly.
2.Wheels and Tires	Ensure tires are inflated within the recommended limits posted on the tire sidewalls and hold air. Ensure tires have good tread, have no bulges or excessive wear, and are free from any other damage. Ensure rims run true and have no obvious wobbles, dents, or kinks. Ensure all wheel spokes are tight and not broken. Check axle nuts and front wheel quick release to ensure they are tight. Ensure the locking lever on the quick release skewer is correctly tensioned, fully closed, and secured.
3.Steering	Ensure the handlebar and stem are correctly adjusted, tightened, and allow proper steering. Perform a handlebar twist test to ensure the stem clamp bolt security. Ensure the handlebar is set correctly in relation to the fork and the direction of travel
4.Chain	Ensure the chain is clean, oiled, and runs smoothly. Extra care is required in wet, salty/otherwise corrosive, or dusty conditions.
5.Bearings	Ensure all bearings are lubricated, run freely, and display no excess movement, grinding, or rattling. Check headset, wheel bearings, pedal bearings, and bottom bracket bearings.
6.Cranks and Pedals	Ensure pedals are securely tightened to the cranks. Ensure the cranks are securely tightened and are not bent.
7.Derailleur and Mechanical Cables	Check that the derailleur is adjusted and functioning properly. Ensure the shifter and brake levers are attached to the handlebar securely. Ensure all shifter and brake cables are properly lubricated.

8.Frame, Fork, and Seat	<p>Check that the frame and fork are not bent or broken. If either frame or fork are bent or broken, they should be replaced. Check that the seat is adjusted properly, and seatpost quick release lever is securely tightened.</p>
9.Motor Drive Assembly and Throttle	<p>Ensure hub motor is spinning smoothly and motor bearings are in good working order. Ensure all power cables running to hub motor are secured and undamaged. Make sure the hub motor axle bolts are secured and the torque arm, torque arm bolt, and torque washers are in place.</p>
10.Battery	<p>Ensure battery is charged before use. Ensure there is no damage to battery. Lock battery to frame and ensure that it is secured. Charge and store bike and battery in a dry location, between 50 °F - 77 °F (10 °C - 25 °C). Let bike dry completely before using again.</p>
11.Electrical Cables	<p>Look over connectors to make sure they are fully seated and free from debris or moisture. Check cables and cable housing for obvious signs of damage. Ensure front light is functioning, adjusted properly, and unobstructed.</p>
12.Accessories	<p>Ensure all reflectors are properly fitted and not obscured. Ensure all other fittings on bike are properly secured and functioning. Inspect helmet and other safety gear for signs of damage. Ensure rider is wearing a helmet and other required riding safety gear. Ensure mounting hardware is properly secured if fitted with a front rack, rear rack, basket, etc. Ensure the taillight and taillight power wire are properly secured if fitted with rear rack. Ensure the fender mounting hardware is properly secured if fitted with fenders. Ensure there are no cracks or holes in fenders. If installed, ensure the optional rear wheel lock is secured in the unlocked position and the key is removed before every ride.</p>



After the initial break-in period of 50-100 miles (80-160 km), your cables, spokes, and chain may stretch, and bolted connections can loosen. It is essential to have a certified, reputable bike mechanic perform a tune-up after this break-in period, which can vary based on factors like total weight, riding style, and terrain. Regular inspections and tune-ups are crucial to ensuring your bike stays safe and enjoyable to ride.

Tire Inflation and Replacement

The WARRIOR employs 26"×4"rubber tires with inner tubes. The tires are designed for durability and safety for regular cycling activities and need to be checked before each use for proper inflation and condition. Proper inflation, care, and timely replacement will help ensure that your bike's operational characteristics will be maintained, and unsafe conditions avoided.

Freesky recommends 16-20 PSI for the stock tires. Always stay within the manufacturer's recommended air pressure range as listed on the tire sidewall.



It is critically important that proper air pressure is always maintained in pneumatic tires. Do not underinflate or overinflate your tires. Low pressure may result in loss of control, and overinflated tires may burst. Failure to always maintain the air pressure rating indicated on pneumatic tires may result in tire and/or wheel failure.



Inflate your tires from a regulated air source with an available pressure gauge. Inflating your tires from an unregulated air source could overinflate them, resulting in a burst tire.

Even tires equipped with built-in, flat-preventative tire liners, like those that come with bikes from Freesky, can and do get flats from punctures, pinches, impact, and other causes. When tire wear becomes evident or a flat tire is discovered, tires and/or tubes must be replaced before operating the bike or injury to operators and/or damage to your bike from Freesky could occur.



When changing a tire or tube, ensure that all air pressure has been removed from the inner tube prior to removing the tire from the rim. Failure to remove all air pressure from the inner tube could result in serious injury.



Using aftermarket tires or inner tubes, not provided by Freesky may void your warranty, create an unsafe riding condition, or damage your bike. If required by law, ensure replacement aftermarket tires have sufficient reflective sidewall striping.

For more information on torn or tube replacement procedures, or questions about tire inflation, contact Freesky after-sale service at support@freeskycycle.com.

Troubleshooting

Symptoms	Possible Causes	Most Common Solutions
The bike does not work	<ol style="list-style-type: none"> 1. Insufficient battery power 2. Faulty connections 3. Battery not fully seated in tray 4. Improper turn on sequence 5. Brakes are applied 6. Blown discharge fuse 	<ol style="list-style-type: none"> 1. Charge the battery 2. Clean and repair connectors 3. Install battery correctly 4. Turn on bike with proper sequence 5. Disengage brakes 6. Replace discharge fuse
Irregular acceleration and/or reduced top speed	<ol style="list-style-type: none"> 1. Insufficient battery power 2. Loose or damaged throttle 3. Misaligned or damaged magnet ring 	<ol style="list-style-type: none"> 1. Charge or replace battery 2. Replace throttle 3. Align or replace magnet ring
The motor does not respond when the bike is powered on	<ol style="list-style-type: none"> 1. Loose wiring 2. Loose or damaged throttle 3. Loose or damaged motor plug wire 4. Damaged motor 	<ol style="list-style-type: none"> 1. Repair and or reconnect 2. Tighten or replace 3. Secure or replace 4. Repair or replace
Reduced range	<ol style="list-style-type: none"> 1. Low tire pressure 2. Low or faulty battery 3. Driving with too many hills, headwind, braking, and/or excessive load 4. Battery discharged for long period of time without regular charges, aged, damaged, or unbalanced 5. Brakes rubbing 	<ol style="list-style-type: none"> 1. Adjust tire pressure 2. Check connections or charge battery 3. Assist with pedals or adjust route 4. Balance the battery; contact Tech Support if range decline persists 5. Adjust the brakes
The battery will not charge	<ol style="list-style-type: none"> 1. Charger not well connected 2. Charger damaged 3. Battery damaged 4. Wiring damaged 5. Blown charge fuse 	<ol style="list-style-type: none"> 1. Adjust the connections 2. Replace 3. Replace 4. Repair or replace 5. Replace charge fuse
Wheel or motor makes strange noises	<ol style="list-style-type: none"> 1. Loose or damaged wheel spokes or rim 2. Loose or damaged motor wiring 	<ol style="list-style-type: none"> 1. Tighten, repair, or replace 2. Reconnect or replace motor.

Specifications

ITEM	SPECIFICATIONS
Model	WARRIOR
Product Dimensions	198 X 72 X109 (CM)
Package Dimensions	160 X35 X84 CM
Max Load	300 lbs(135kg)
Package Weight	50.5KG
E-Bike Weight	40.7KG
Battery/Charger	Input 100-240V 50/60HZ AC Plug; Output 54.6V 3A
Charging Time	4-8 hours
Tire Pressure	18-20 PSI
Recommended Rider Heights	5'5"-6'3" (165-191CM)
Frame Material	Artificial Mechanics 6061 Aluminum Alloy Frame
IP Level	Ip65

Warranty

The warranty is non-transferable and only applies to the original owner. This warranty gives you specific rights and purchasers may also have other rights, which may vary from state to state. Damage caused by failing to follow instructions in the manual, acts of God, accident, misuse, neglect, abuse, commercial use, alterations, modification, improper assembly, installation of parts or accessories not originally intended or compatible with the Freesky eBike as sold, operator error, water damage, extreme riding, stunt riding, or improper follow-up maintenance is not covered under this warranty.

Warranty parts will only be shipped within the continental United States. Parts covered by the warranty: frame, forks, stem, handlebars, headset, seat post, saddle, brakes (excluding brake pads), lights, bottom bracket, crank set, pedals, rims, wheel hub, freewheel, cassette, derailleur, shifter, motor, throttle, controller, wiring harness, display (excluding damage due to water), kickstand, reflectors, and hardware. The battery warranty does not include damage from power surges, use of 3rd party charger, improper maintenance or other such misuse, normal wear, or water damage (including rust).

Accessories sold on [freeskycycle.com](https://www.freeskycycle.com) are not covered under warranty. Stolen bikes are not covered under warranty.

Necessary precautions must be taken to ensure the bike and battery are not exposed to severe weather conditions. Exposure to very wet, hot, or cold conditions may void the warranty.

Freesky eBikes will replace any parts deemed to have been damaged during shipping. Shipping damage must be reported to Freesky eBikes within 7 days of shipment arrival. This applies to all products, including bikes and accessories. You will NOT be refunded as compensation for your time or efforts replacing damaged parts.

Replacement parts will not be sent until photographic evidence has been provided to Freesky eBikes. Freesky eBikes may request additional documentation (such as video) to assist with accurately diagnosing the

problem and processing the warranty claim.

Most warranty parts will be fulfilled in 5 business days after the request is put into our system by a customer service representative. Warranty parts will be sent from our American warehouse if stock is available, or we will ship from China factory, where the shipping time takes around 2 weeks. Warranty parts will not be expedited. Items including the chain, tires, wheels, rims, tubes, battery handle, brake rotors, brake pads, cables and housings, grips, and spokes are considered wear items. These items wear down with normal use and are not covered under warranty. You are responsible for replacing and maintaining these wear items. Any unauthorized alterations or repairs are not covered and may void this warranty.

For warranty services, please contact Freesky ebike's online support by email at support@freeskycycle.com. Bikes or parts returned without proper documentation may result in delayed service or denied warranty coverage. Warranty return shipping costs along with duties and taxes are the responsibility of the claimant. All unauthorized returns will be refused.

Note that your insurance policies may not provide coverage for accidents involving Freesky eBikes. To determine if coverage is provided, you should contact your insurance company or agent.

Damage as a result of an accident is not covered under this warranty, and Freesky eBikes is not responsible for repair or replacement of damaged bikes or parts.

Freesky eBikes reserves the right to change its warranty at any time and without notice.

Any action, lawsuit or other proceeding, under this warranty or otherwise related to the bike must be commenced within ninety (90) days after expiration of the one-year warranty period.

Bike Performance Disclaimer

The listed range and top speed of the bike are estimates, not guarantees of performance. Various factors will affect actual performance, including rider weight, cargo weight, shape (which affects drag), terrain, tire pressure, brake adjustment, throttle & PAS usage, pedal power, battery charge level, ambient temperature, and wind conditions. It is possible to achieve different ranges and top speeds than the listed estimates.

To maximize the range per battery charge:

- Ride at a lower PAS level.
- Use lower PAS levels and pedal when climbing hills.
- Pedal when starting from a standstill.

Refund Policy

PARTS DAMAGED :

Ebikes from Freesky may experience some damage because of long-time transportation, send us pictures immediately after you get the items, After approval, we will send you replacement parts or a partial refund upon agreement.

EBIKE RETURNS :

Ebikes from Freesky are under a 15-day return policy, which means you have 15 days after receiving your item to request a return. To return an e-bike that is not defective or damaged please contact the customer service team within 15 days. We do not provide product returns service after 15 days, as same as refund.

Please make sure the following if you need to return the bike :

1. The mileage on the LCD screen of the e-bike must be less than 10 miles.
2. There should be no wear, dirt, scratches, fragrances, or any other signs of use.
3. All items (chargers, keys, hardware, etc.) received by the customer must be included in the original packaging (all cardboard and foam) and in the same condition.

You will be responsible for paying the shipping costs for returning your item under this condition :

Original and return shipping costs are nonrefundable, and we do charge a restocking fee of up to 25% of order value for the return, Return shipping fees may vary depending upon the chosen freight carrier, Customers are responsible for arranging the return shipping and paying any fees.

We recommend using a trackable shipping service and purchasing shipping insurance. Before a return is sent, the customer must have written approval of said return from Freesky. If a customer sends a return without the written consent of Freesky, a refund will not be issued and the customer will have to pay for shipping to get the item returned, or sacrifice the item. Once we receive the item, we will conduct a detailed inspection of the package, then we will either replace the item or give you a partial refund according to the actual condition of the item we received. This will be issued in 2-5 business days, for an e-bike that has been delivered for more than 15 days or used for more than 10 miles.

If there is any problem, we do not accept returns anymore, only repairs and replacements are allowed.

LATE OR MISSING REFUNDS

If you haven't received a refund after 5 business days of approval, please check your bank account again and contact your credit card company/bank as it may take some time before your refund is officially posted. There is often some processing time before a refund is posted. If you've done all of this and you still

1. have not received your refund, please contact us at: service@freeskycycle.com.

Compliance with the Law

Riders are responsible for adhering to all local, state, and federal laws and regulations regarding the operation of electric bicycles. It is crucial to familiarize yourself with and follow applicable laws, including those related to helmet use, speed limits, and where electric bikes are permitted. Failure to comply with the law may result in fines, legal consequences, or increased risk of injury. Freesky is not liable for any legal issues or penalties incurred due to non-compliance with regulations.

Observe Laws Regarding the Use of Battery-Operated Bicycles

Your e-bike has been designed and manufactured to meet safety standards as a battery-operated bicycle. However, laws regulating the use of battery-operated bicycles on public roads, parks, and other open areas may vary by state and locality. It is important to consult with your local authorities before riding your e-bike in public areas to ensure compliance with all applicable regulations.

Observe Laws Regarding the Use of Bicycles

Please be aware that all laws governing the use of bicycles in public areas, including those requiring helmets and infant seats, also apply to e-bikes. It is important to check with your local authority to understand any specific restrictions or regulations that may be in place for electric bicycles.

The Lithium-Ion Battery of Your E-Bike

Your e-bike features advanced lithium-ion battery technology, which is significantly lighter compared to older lead- or nickel-based batteries used in some previous models.

Your First Ride

Exercise extreme caution when taking your e-bike for the first time, as it can accelerate much faster than a regular bicycle when in power-assisted mode. Start by riding in a spacious area to give yourself plenty of room. Avoid pedaling hard immediately upon mounting the e-bike, as the pedal-assist mode will cause a rapid increase in speed that might catch you off guard. With a bit of practice, you'll become accustomed to and enjoy the benefits of the pedal-assisted function.

IMPORTANCE

Please review this owner's manual thoroughly before operating your Warrior Pro M-530 to fully understand the proper use of the bike's controls, features, capabilities, and limitations. While this handbook offers safety tips for riding, it does not cover the techniques and skills

required to ride an electric bicycle safely.

This owner's manual provides instructions for assembly and maintenance tasks that may need to be done regularly to keep your Warrior Pro M-530 in safe and working condition. Never attempt to perform tasks on your bike beyond what is outlined in this manual. It is not intended as a complete guide for usage, service, repair, or maintenance. Do NOT ride your Warrior Pro M-530 if it has been improperly assembled. An Ebike specialist or professional cycle mechanic should handle any maintenance outside the scope of this manual. Riding an improperly assembled bike can endanger your safety and that of others.

Liability Disclaimer

Riding any type of bicycle involves inherent risks and potential dangers that cannot be foreseen or avoided, and these risks may lead to serious accidents, injury, or even death. It is the rider's sole responsibility to become fully educated and adequately prepared to ride safely. Once the bike is in your possession, Freesky highly recommends and urges all customers to have a certified, reputable bicycle mechanic perform a complete inspection of all components to ensure safe operation. Before each ride, thoroughly inspect your bicycle to confirm that all parts are securely fastened and properly adjusted.

Freesky is not liable under any circumstances for damage caused by defective, damaged, or improperly secured parts. This includes but is not limited to, damage to personal property, personal injury, or death.

Disclaimer: Riders must be 18 years of age or older to operate this bicycle.